



ELSAN Elektrik San. ve Tic. A.Ş.
 Etiler Mah. 1458. Cad. No:40
 06790 Etimesgut / Ankara / TÜRKİYE
 T: +90 312 244 09 94 F: +90 312 243 14 38
 M: info@emtas.com.tr W: www.emtas.com.tr



TECHNICAL SPECIFICATION SHEET

THREE PHASES SQUIRREL CAGE ASYNCHRONOUS MOTORS

Type	NMST 315S8		
Protection Class	IP 65		
Duty Type / Service Factor	S1	1.0	
Insulation Class	H		
Construction Type /Frame	B3/ 315S8		
Altitude / Ambient temperature	1000 m	40 C°	
Customer / Date / Order Number	-	7.07.2023	-

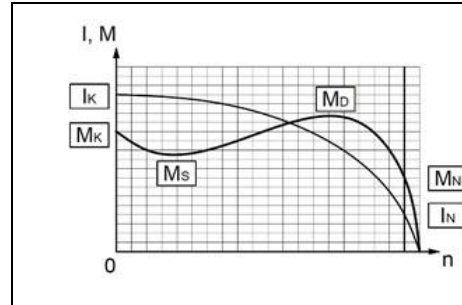

PERFORMANCE DATA (FULL LOAD)

Rated Output (kW)	Rated Speed (1/min)	Voltage (V)	Frequency (Hz)	Current (A)	Efficiency (%)	Power Factor (Cos φ)	Rated Torque MN (Nm)	Starting Current IK/IN	Starting Torque MK/MN	Breakdown Torque MD/MN	Moment of Inertia Jmot (kgm ²)
55	738	400	50	110,0	92,5	0,78	711,7	5,0	2,0	2,3	2,262

CHARACTERISTIC DATA

Frame	Cast Iron (GG20)	Bearings	Standart			Drive End Bearing	Non Drive End Bearing
End Shield - DE and NDE	Cast Iron (GG20)		Heavy Duty			6319	6318
Foot	Ductile Iron (GGG40)					NU 319	-
Fan	Plastic	Special Equipment	Brake	Forced ventilation	Heater	Encoder	Heat sensor
Terminal box	Cast Iron (GG20)		---	---	<input type="checkbox"/>	---	---
Cable Gland	Brass 2 x Pg48	Colour	RAL 6028 - Green			Weight (kg)	600

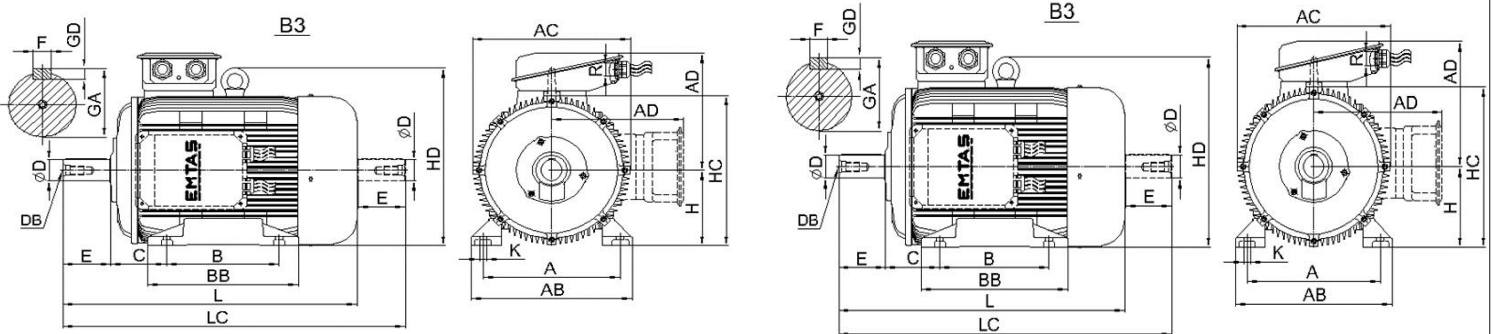

DIMENSIONS (mm) (B3-B5-V1-V5-V6-B6-B7-B8-B35)

B3											B5						Common Dimensions										
H	A	B	C	AB	AC	AD	BB	HC	HD	K	P	N	M	S	Hole Pcs.	T	LA	LB	LC	L	ØD	E	F	GA	GD	DB	R
315,0	508,0	406,0	216,0	620,0	612,0	501,0	500,0	621,0	682,0	28,0	660,0	550,0	600,0	24,0	8,0	6,0	24,0	---	1298,0	1120,0	85,0	170,0	22,0	90,0	14,0	M20	2 x Pg48

Important Note : Values provided in this datasheet represent the preliminary design values. Please keep in mind that these values might vary for the final product, due to technical requirements.