



ELSAN Elektrik San. ve Tic. A.Ş.
 Etiler Mah. 1458. Cad. No:40
 06790 Etimesgut / Ankara / TÜRKİYE
 T: +90 312 244 09 94 F: +90 312 243 14 38
 M: info@emtas.com.tr W: www.emtas.com.tr



TECHNICAL SPECIFICATION SHEET

THREE PHASES SQUIRREL CAGE ASYNCHRONOUS MOTORS

Type	NMSC 180Lb		
Protection Class	IP55		
Duty Type / Service Factor	S1	1.0	
Insulation Class	H		
Construction Type /Frame	B35/ 180Lb		
Altitude / Ambient temperature	1000 m	40 C°	
Customer / Date / Order Number	-	11.01.2024	-

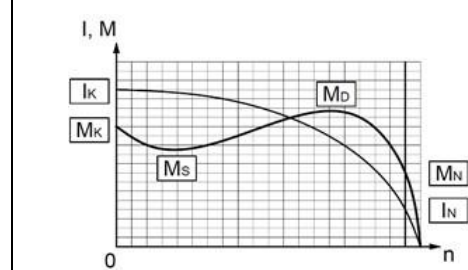

PERFORMANCE DATA (FULL LOAD)

Rated Output (kW)	Rated Speed (1/min)		Voltage (V)	Frequency (Hz)	Current (A)		Efficiency (%)	Power Factor (Cos φ)		Rated Torque MN (Nm)		Starting Current IK/IN		Starting Torque MK/MN		Breakdown Torque MD/MN	Moment of Inertia Jmot (kgm²)
	710	1445			24,0	29,0		0,81	0,92	148,0	99,1	7,4	5,3	1,7	1,7		

CHARACTERISTIC DATA

Frame	Cast Iron (GG20)	Bearings	Standart			Drive End Bearing	Non Drive End Bearing
End Shield - DE and NDE	Cast Iron (GG20)		Heavy Duty			6310 ZZ	6310 ZZ
Foot	Ductile Iron (GGG40)					-	-
Fan	Plastic	Special Equipment	Brake	Forced ventilation	Heater	Encoder	Heat sensor
Terminal box	Aluminium		---	---	<input type="checkbox"/>	---	---
Cable Gland	PA6.6 2 x Pg21	Colour	RAL 6028 - Green			Weight (kg)	176

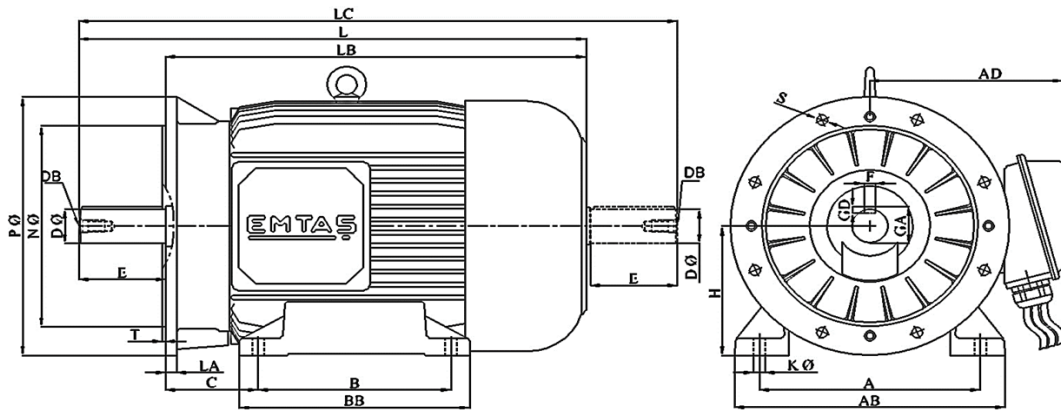

DIMENSIONS (mm) (B3-B5-V1-V5-V6-B6-B7-B8-B35)

B3										B5							Common Dimensions										
H	A	B	C	AB	AC	AD	BB	HC	HD	K	P	N	M	S	Hole Pcs.	T	LA	LB	LC	L	ØD	E	F	GA	GD	DB	R
180,0	279,0	279,0	121,0	360,0	348,0	250,0	327,0	354,0	411,0	15,0	350,0	250,0	300,0	19,0	4,0	5,0	18,0	541,0	772,0	651,0	48,0	110,0	14,0	51,5	9,0	*	2 x Pg21

Important Note : Values provided in this datasheet represent the preliminary design values. Please keep in mind that these values might vary for the final product, due to technical requirements.