



ELSAN Elektrik San. ve Tic. A.Ş.
 Etiler Mah. 1458. Cad. No:40
 06790 Etimesgut / Ankara / TÜRKİYE
 T: +90 312 244 09 94 F: +90 312 243 14 38
 M: info@emtas.com.tr W: www.emtas.com.tr



TECHNICAL SPECIFICATION SHEET

THREE PHASES SQUIRREL CAGE ASYNCHRONOUS MOTORS

Type	NMSC 160Lb		
Protection Class	IP55		
Duty Type / Service Factor	S1	1.0	
Insulation Class	H		
Construction Type /Frame	B35/ 160Lb		
Altitude / Ambient temperature	1000 m	40 C°	
Customer / Date / Order Number	-	11.01.2024	-

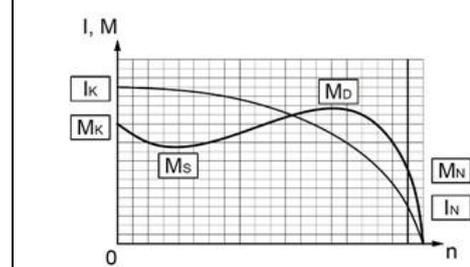

PERFORMANCE DATA (FULL LOAD)

Rated Output (kW)	Rated Speed (1/min)	Voltage (V)	Frequency (Hz)	Current (A)	Efficiency (%)	Power Factor (Cos φ)	Rated Torque MN (Nm)	Starting Current IK/IN	Starting Torque MK/MN	Breakdown Torque MD/MN	Moment of Inertia Jmot (kgm²)
3,7-7,5	478 951	400	50	16,0 15,0	89,4	0,54 0,88	73,9 75,3	3,4 5,6	2,0 1,6	3,2	0,044

CHARACTERISTIC DATA

Frame	Cast Iron (GG20)	Bearings	Standart			Drive End Bearing	Non Drive End Bearing
End Shield - DE and NDE	Cast Iron (GG20)		Heavy Duty			6309 ZZ	6309 ZZ
Foot	Ductile Iron (GGG40)					-	-
Fan	Plastic	Special Equipment	Brake	Forced ventilation	Heater	Encoder	Heat sensor
Terminal box	Aluminium		---	---	<input type="checkbox"/>	---	---
Cable Gland	PA6.6 2 x Pg21	Colour	RAL 6028 - Green			Weight (kg)	134

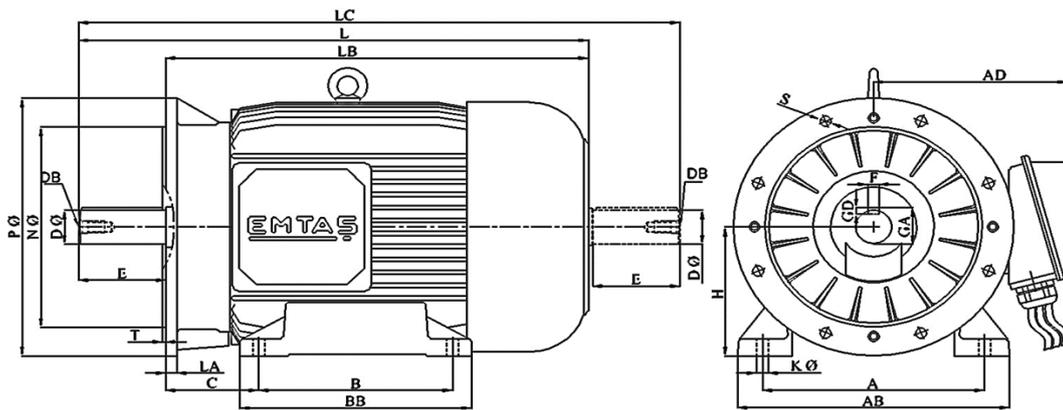

DIMENSIONS (mm) (B3-B5-V1-V5-V6-B6-B7-B8-B35)

B3										B5							Common Dimensions										
H	A	B	C	AB	AC	AD	BB	HC	HD	K	P	N	M	S	Hole Pcs.	T	LA	LB	LC	L	ØD	E	F	GA	GD	DB	R
160,0	254,0	254,0	108,0	318,0	310,0	236,0	304,0	315,0	373,0	15,0	350,0	250,0	300,0	19,0	4,0	5,0	18,0	503,0	729,0	613,0	42,0	110,0	12,0	45,0	8,0	*	2 x Pg21

Important Note : Values provided in this datasheet represent the preliminary design values. Please keep in mind that these values might vary for the final product, due to technical requirements.