



**ELSAN Elektrik San. ve Tic. A.Ş.**  
 Etiler Mah. 1458. Cad. No:40  
 06790 Etimesgut / Ankara / TÜRKİYE  
 T: +90 312 244 09 94 F: +90 312 243 14 38  
 M: info@emtas.com.tr W: www.emtas.com.tr



## TECHNICAL SPECIFICATION SHEET

### THREE PHASES SQUIRREL CAGE ASYNCHRONOUS MOTORS

Type	NMST 200L8		
Protection Class	IP55		
Duty Type / Service Factor	S1	1.0	
Insulation Class	H		
Construction Type /Frame	B3/ 200L8		
Altitude / Ambient temperature	1000 m	40 C°	
Customer / Date / Order Number	-	7.07.2023	-

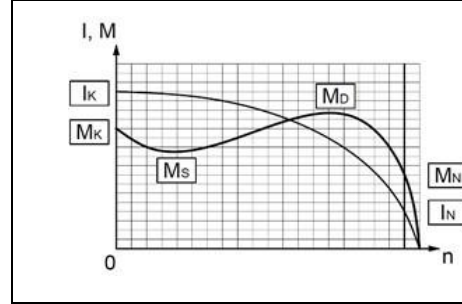

### PERFORMANCE DATA ( FULL LOAD )

Rated Output (kW)	Rated Speed (1/min)	Voltage (V)	Frequency (Hz)	Current (A)	Efficiency (%)	Power Factor (Cos φ)	Rated Torque MN (Nm)	Starting Current IK/IN	Starting Torque MK/MN	Breakdown Torque MD/MN	Moment of Inertia Jmot (kgm²)
15	730	400	50	31,0	88,5	0,79	196,2	6,0	2,1	2,9	0,412

### CHARACTERISTIC DATA

Frame	Cast Iron (GG20)	Bearings	Standart			Drive End Bearing	Non Drive End Bearing
End Shield - DE and NDE	Cast Iron (GG20)		Heavy Duty			6313 ZZ	6313 ZZ
Foot	Ductile Iron (GGG40)					-	-
Fan	Plastic	Special Equipment	Brake	Forced ventilation	Heater	Encoder	Heat sensor
Terminal box	Aluminium		---	---	<input type="checkbox"/>	---	---
Cable Gland	PA6.6 2 x Pg29	Colour	RAL 6028 - Green		Weight (kg)	242	

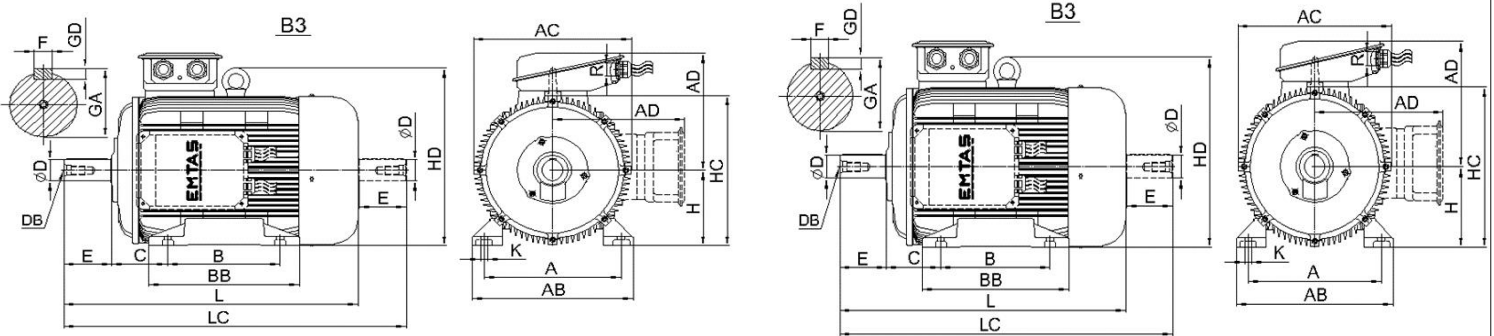

### DIMENSIONS (mm) ( B3-B5-V1-V5-V6-B6-B7-B8-B35 )

B3										B5							Common Dimensions										
H	A	B	C	AB	AC	AD	BB	HC	HD	K	P	N	M	S	Hole Pcs.	T	LA	LB	LC	L	ØD	E	F	GA	GD	DB	R
200,0	318,0	305,0	133,0	400,0	385,0	319,0	365,0	394,0	460,0	19,0	400,0	300,0	350,0	19,0	4,0	5,0	18,0	---	876,0	759,0	55,0	110,0	16,0	59,0	10,0	*	2 x Pg29

Important Note : Values provided in this datasheet represent the preliminary design values. Please keep in mind that these values might vary for the final product, due to technical requirements.