



TECHNICAL SPECIFICATION SHEET

THREE PHASES SQUIRREL CAGE ASYNCHRONOUS MOTORS

Type	VHS - DKPM-S 160/4		
Protection Class	IP55		
Duty Type / Service Factor	VFD S1	1.0	
Insulation Class	F		
Construction Type /Frame	V1 / 315		
Altitude / Ambient temperature	1000 m	40 C°	
Customer / Date / Order Number	-	17.01.2024	-



PERFORMANCE DATA (FULL LOAD)

Rated Output (kW)	Rated Speed (1/min)	Voltage (V)	Frequency (Hz)	Current (A)	Efficiency (%)	Power Factor (Cos φ)	Rated Torque MN (Nm)	Starting Current Ratio IK/IN	Starting Torque Ratio MK/MN	Breakdown Torque Ratio MD/MN	Permissible Axial Force (kN)
192	1786	460	60	285,8	95,80	0,88	1026,9	7,00	2,00	2,30	3434,0

CHARACTERISTIC DATA

Frame	Cast Iron (GG20)	Bearings	Standart		Drive End Bearing	Non Drive End Bearing
End Shield - DE and NDE	Cast Iron (GG20)		7322		6315	
Foot	-					
Fan	Plastic	Special Equipment	<input type="checkbox"/> Heater	<input type="checkbox"/> Heat sensor		
Terminal box	Aluminium	Colour	RAL 2011 - Orange			
Cable Gland	Brass - Pg48	Weight (kg)	860			

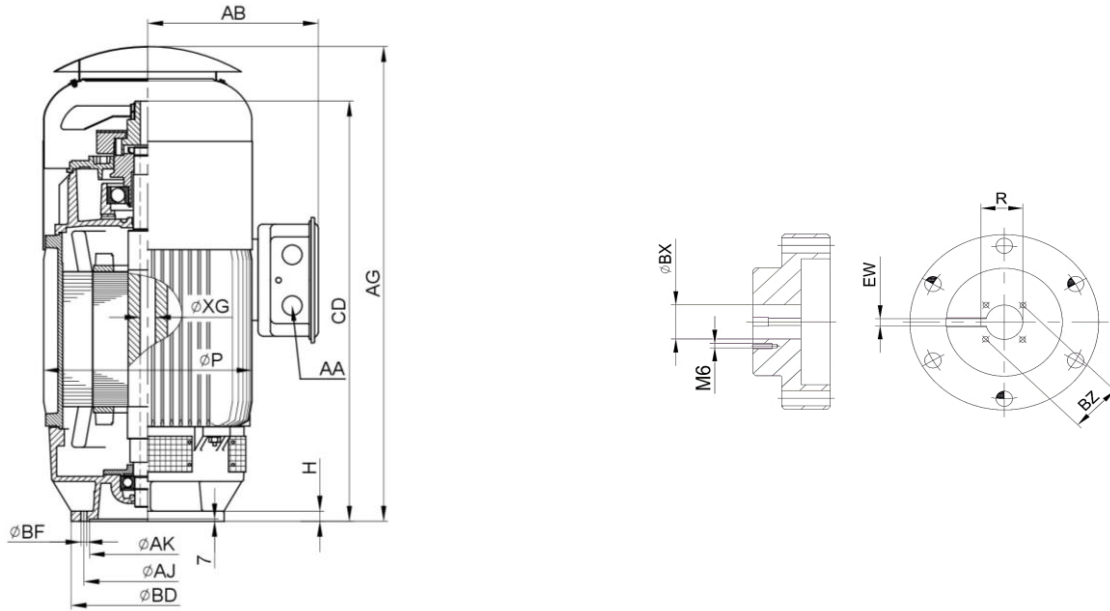

DIMENSIONS (mm) (Frame and Coupling)

Frame											Coupling			
H	AK	AJ	BD	AA	CD	AG	AB	P	XG	BF	BX	EW	BZ	R
30	343	375	450	Pg48	1252	1414	501	612	45	17,5	42,9	9,52	63,5	47,22