



TECHNICAL SPECIFICATION SHEET

THREE PHASES SQUIRREL CAGE ASYNCHRONOUS MOTORS

Type	VHS - DKPM-S 250/4		
Protection Class	IP55		
Duty Type / Service Factor	VFD S1	1.0	
Insulation Class	F		
Construction Type /Frame	V1 / -		
Altitude / Ambient temperature	1000 m	40 C°	
Customer / Date / Order Number	-	17.01.2024	-



PERFORMANCE DATA (FULL LOAD)

Rated Output (kW)	Rated Speed (1/min)	Voltage (V)	Frequency (Hz)	Current (A)	Efficiency (%)	Power Factor (Cos φ)	Rated Torque MN (Nm)	Starting Current Ratio IK/IN	Starting Torque Ratio MK/MN	Breakdown Torque Ratio MD/MN	Permissible Axial Force (kN)
300	1788	460	60	440,7	96,00	0,89	1602,3	7,00	2,00	2,00	-

CHARACTERISTIC DATA

Frame	Cast Iron (GG20)	Bearings	Drive End Bearing	Non Drive End Bearing
End Shield - DE and NDE	Cast Iron (GG20)		Standart	-
Foot	-		-	-
Fan	Plastic	Special Equipment	<input type="checkbox"/> Heater	<input type="checkbox"/> Heat sensor
Terminal box	Aluminium	Colour	RAL 2011 - Orange	
Cable Gland	Brass - -	Weight (kg)	1110	

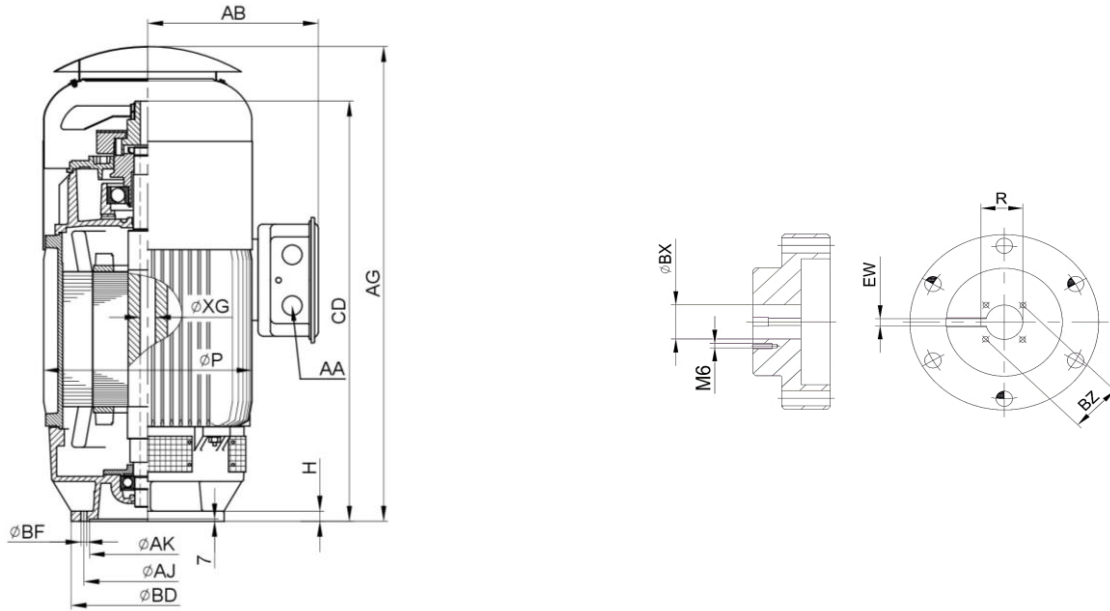

DIMENSIONS (mm) (Frame and Coupling)

Frame											Coupling			
H	AK	AJ	BD	AA	CD	AG	AB	P	XG	BF	BX	EW	BZ	R
-	-	-	-	-	-	-	-	-	-	-	-	-	-	-