

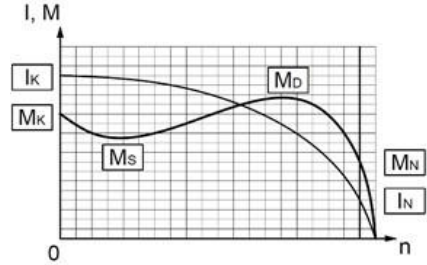

TECHNICAL SPECIFICATION SHEET

THREE PHASES SQUIRREL CAGE ASYNCHRONOUS MOTORS

Type	VHS - DKPM-S 110/4		
Protection Class	IP55		
Duty Type / Service Factor	VFD S1	1.0	
Insulation Class	F		
Construction Type /Frame	V1 / 315		
Altitude / Ambient temperature	1000 m	40 C°	
Customer / Date / Order Number	-	17.01.2024	-



PERFORMANCE DATA (FULL LOAD)

Rated Output (kW)	Rated Speed (1/min)	Voltage (V)	Frequency (Hz)	Current (A)	Efficiency (%)	Power Factor (Cos φ)	Rated Torque MN (Nm)	Starting Current Ratio IK/IN	Starting Torque Ratio MK/MN	Breakdown Torque Ratio MD/MN	Permissible Axial Force (kN)
132	1786	460	60	201,9	95,40	0,86	706,0	6,00	1,80	2,50	3360,0

CHARACTERISTIC DATA

Frame	Cast Iron (GG20)	Bearings	Standart		Drive End Bearing	Non Drive End Bearing
End Shield - DE and NDE	Cast Iron (GG20)		7320		6315	
Foot	-					
Fan	Plastic	Special Equipment	<input type="checkbox"/> Heater	<input type="checkbox"/> Heat sensor	-	
Terminal box	Aluminium	Colour	RAL 2011 - Orange			
Cable Gland	PA6.6 - Pg36	Weight (kg)	654			

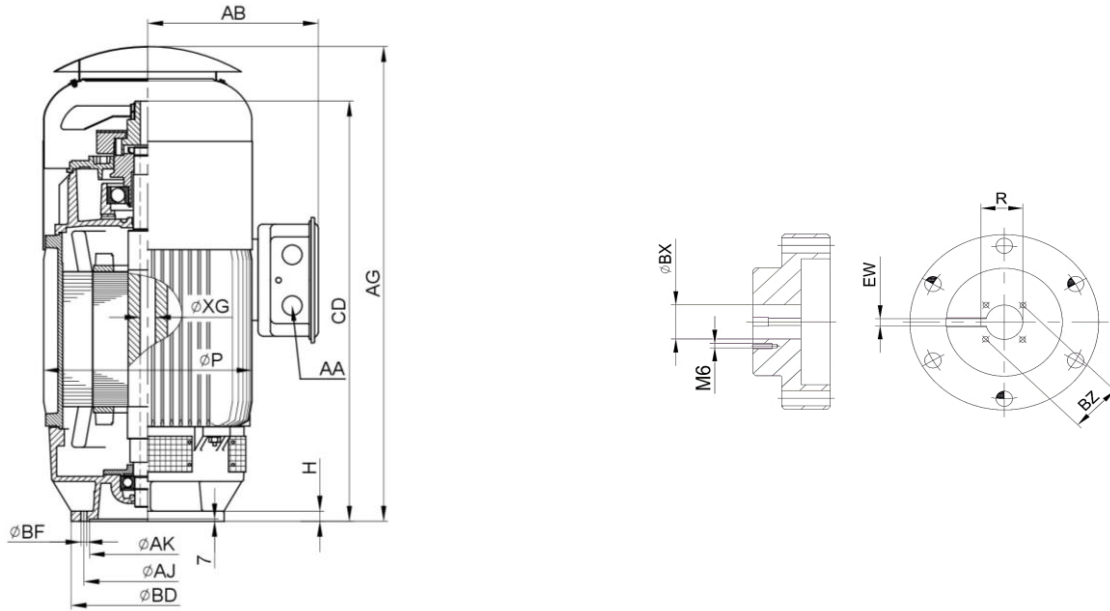

DIMENSIONS (mm) (Frame and Coupling)

Frame											Coupling			
H	AK	AJ	BD	AA	CD	AG	AB	P	XG	BF	BX	EW	BZ	R
24	343	375	430	Pg36	1153	1273	381	536	38,5	17,5	38,2	9,52	54	42,4

Important Note - Values provided in this datasheet represent the preliminary design values. Please keep in mind that these values might vary for the final product, due to technical requirements.