



ELSAN Elektrik San. ve Tic. A.Ş.
 Etiler Mah. 1458. Cad. No:40
 06790 Etimesgut / Ankara / TÜRKİYE
 T: +90 312 244 09 94 F: +90 312 243 14 38
 M: info@emtas.com.tr W: www.emtas.com.tr



TECHNICAL SPECIFICATION SHEET

THREE PHASES SQUIRREL CAGE ASYNCHRONOUS MOTORS

Type	NMSF 90L4		
Protection Class	IP55		
Duty Type / Service Factor	S2 - 240 dk	1.0	
Insulation Class	F		
Construction Type /Frame	B3/ 90L4		
Altitude / Ambient temperature	1000 m	40 C°	
Customer / Date / Order Number	-	12.03.2026	-



PERFORMANCE DATA (FULL LOAD)

Rated Output (kW)	Rated Speed (1/min)	Voltage (V)	Frequency (Hz)	Current (A)	Efficiency (%)	Power Factor (Cos φ)	Rated Torque MN (Nm)	Starting Current IK/IN	Starting Torque MK/MN	Breakdown Torque MD/MN	Moment of Inertia Jmot (kgm²)
1,5	1418	400	50	3,4	77,4	0,82	10,1	5,0	2,4	2,6	0,003

CHARACTERISTIC DATA

Frame	Cast Iron (GG20)	Bearings	Standart			Drive End Bearing	Non Drive End Bearing
End Shield - DE and NDE	Cast Iron (GG20)		Heavy Duty			6205 ZZ	6205 ZZ
Foot	Ductile Iron (GGG40)					NU 205	-
Fan	Plastic	Special Equipment	Brake	Forced ventilation	Heater	Encoder	Heat sensor
Terminal box	Cast Iron (GG20)		40 Nm brake	---	<input type="checkbox"/>		
Cable Gland	PA6.6 2 x Pg13,5	Colour	RAL 6028 - Green			Weight (kg)	33

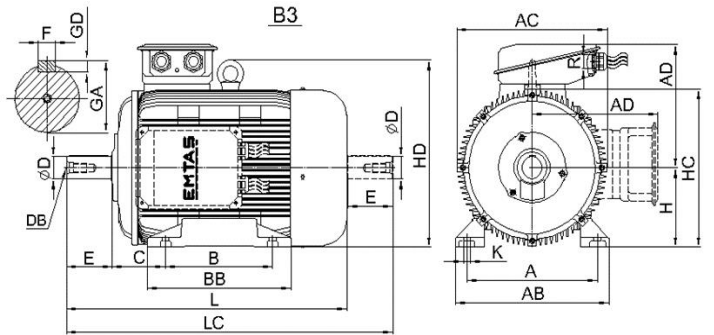
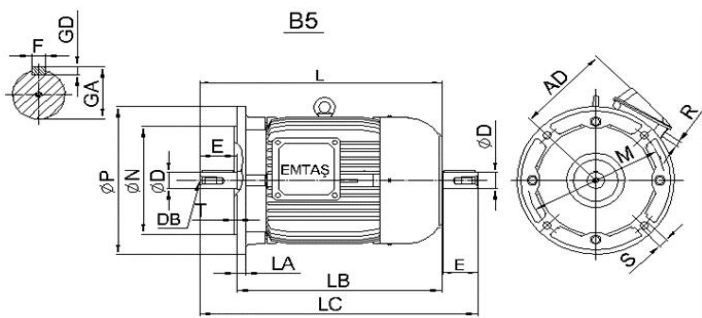

DIMENSIONS (mm) (B3-B5-V1-V5-V6-B6-B7-B8-B35)

B3											B5											Common Dimensions									
H	A	B	C	AB	AC	AD	BB	HC	HD	K	P	N	M	S	Hole Pcs.	T	LA	LB	LC	L	ØD	E	F	GA	GD	DB	R				
90,0	140,0	125,0	56,0	185,0	176,0	127,0	150,0	178,0	-	10,0	200,0	130,0	165,0	12,0	4,0	3,5	11,0	---	472,0	411,0	24,0	50,0	8,0	27,0	7,0	*	2 x Pg13,5				

Important Note : Values provided in this datasheet represent the preliminary design values. Please keep in mind that these values might vary for the final product, due to technical requirements.